

1 μ A Voltage Detector with Output Delay

Features

- Precise Detection Thresholds: $\pm 2.0\%$
- Small Package: 3-Pin SOT-23A
- Low Supply Current: Typ. 1 μ A
- Wide Detection Range: 1.6V to 6.0V
- Wide Operating Voltage Range: 0.7V to 10V
- Built-in Delay Circuit: 50msec to 200 msec
- Open-Drain Output

Applications

- Battery Voltage Monitoring
- Microprocessor Reset
- System Brown-out Protection

Device Selection Table

Part Number	Package	Temp. Range
TC51-xxxxxxxxx	3-Pin SOT-23A	-40°C to +85°C

Other output voltages are available. Please contact Microchip Technology Inc. for details.

Package Type

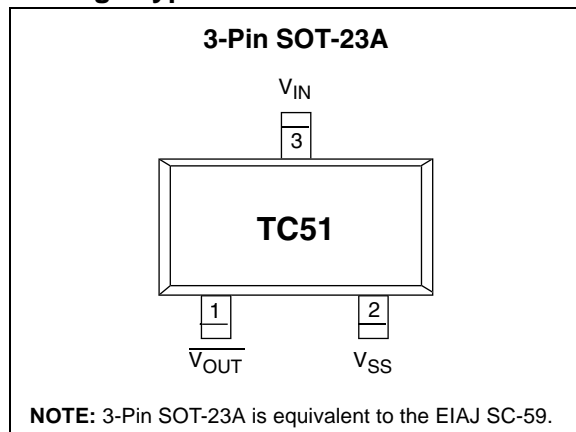

General Description

The TC51 is a very low power, open drain output, CMOS voltage detector with built-in delay. It is particularly well-suited for battery powered applications because of its extremely low 1 μ A operating current and small surface-mount packaging. Each part is laser-trimmed to the desired threshold voltage, which can be specified from 1.6V to 6.0V. The standard built-in output delay is 50msec-200msec.

The device includes a comparator, low-current high-precision reference, laser-programmed voltage divider, hysteresis circuit and output driver with digital delay timer.

In operation, the TC51's output ($\overline{V_{OUT}}$) remains in the logic HIGH state as long as V_{IN} is greater than the specified threshold voltage (V_{DET-}). When V_{IN} falls below V_{DET-} , the output is immediately driven to a logic LOW. $\overline{V_{OUT}}$ remains LOW until V_{IN} rises above V_{DET-} by an amount V_{HYST} , whereupon it returns to a logic HIGH after expiration of the built-in delay time.

Functional Block Diagram

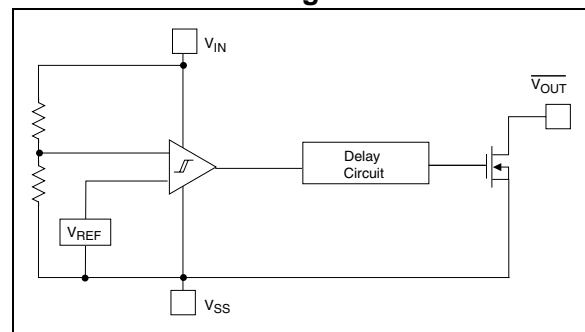

TC51

1.0 ELECTRICAL CHARACTERISTICS

Absolute Maximum Ratings*

Input Voltage+12V
 Output Current50mA
 Output Voltage: Open Drain($V_{SS} - 0.3V$) to 12V
 Power Dissipation ($T_A \leq 70^\circ C$):
 3-Pin SOT-23A240mW
 Operating Temperature Range.....-40°C to +85°C
 Storage Temperature Range-65°C to +150°C

*Stresses above those listed under "Absolute Maximum Ratings" may cause permanent damage to the device. These are stress ratings only and functional operation of the device at these or any other conditions above those indicated in the operation sections of the specifications is not implied. Exposure to Absolute Maximum Rating conditions for extended periods may affect device reliability.

TC51 ELECTRICAL SPECIFICATIONS

Electrical Characteristics: $T_A = 25^\circ C$, unless otherwise specified.						
Symbol	Parameter	Min	Typ	Max	Units	Test Conditions
V_{IN}	Operating Voltage	0.7	—	10.0	V	(V_{DET^-}) = 1.6 to 6.0V
I_{SS}	Quiescent Current	—	0.9	2.6	μA	$V_{IN} = 1.5V$ $V_{IN} = 2.0V$ $V_{IN} = 3.0V$ $V_{IN} = 4.0V$ $V_{IN} = 5.0V$
		—	1.0	3.0		
		—	1.3	3.4		
		—	1.6	3.8		
		—	2.0	4.2		
V_{DET^-}	Threshold Voltage	$V_T \times 0.98$	$V_T \pm 0.5\%$	$V_T \times 1.02$	V	Note 1
V_{HYST}	Hysteresis Voltage	$V_{DET^-} \times 0.02$	$V_{DET^-} \times 0.05$	$V_{DET^-} \times 0.08$	V	
I_{OUT}	Output Current	—	2.2	—	mA	$V_{OL} = 0.5V, V_{IN} = 1.0V$ $V_{IN} = 2.0V$ $V_{IN} = 3.0V$ $V_{IN} = 4.0V$ $V_{IN} = 5.0V$
		—	7.7	—		
		—	10.1	—		
		—	11.5	—		
		—	13.0	—		
T_{DLY}	Delay Time	50	—	200	msec	Standard
$T_C (V_{DET^-})$	Tempco of (V_{DET^-})	—	± 100	—	ppm/ $^\circ C$	$-40^\circ C \leq T_A \leq 85^\circ C$

Note 1: V_T is the factory programmed threshold voltage setting.

2.0 PIN DESCRIPTIONS

The descriptions of the pins are listed in Table 2-1.

TABLE 2-1: PIN FUNCTION TABLE

Pin No. (3-Pin SOT-23A)	Symbol	Description
1	$\overline{V_{OUT}}$	Digital output. This output goes low when V_{IN} drops below V_{DET-} and returns high when V_{IN} rises above $V_{DET-} + V_{HYST}$. (See Figure 3-1, Timing Diagram).
2	V_{SS}	Ground terminal.
3	V_{IN}	Analog input. This pin is both the power supply input and the voltage to be monitored.

3.0 DETAILED DESCRIPTION

In normal steady-state operation, when $V_{IN} > V_{DET-}$, the output is high, see Figure 3-1. If and when the input falls below V_{DET-} , the output pulls down (Logic 0) to V_{SS} . Generally, V_{OUT} can pull down to within 0.5V of V_{SS} at rated output current and input voltage. (Also see Section 1.0, Electrical Characteristics).

The output, $\overline{V_{OUT}}$, stays valid until the input voltage falls below the minimum operating voltage, V_{INMIN} , of 0.7V. Below this minimum operating voltage, the output is undefined. During power-up or anytime V_{IN} has fallen below V_{INMIN} , $\overline{V_{OUT}}$ will remain undefined until V_{IN} rises above V_{INMIN} , at which time the output becomes valid. $\overline{V_{OUT}}$ is maintained in its active low state while $V_{INMIN} < V_{IN} < V_{DET+}$. ($V_{DET+} = V_{DET-} + V_{HYST}$). If and when the input rises above V_{DET+} , the output will assume its inactive state after Delay Time (T_{DLY}).

FIGURE 3-1: TIMING DIAGRAM

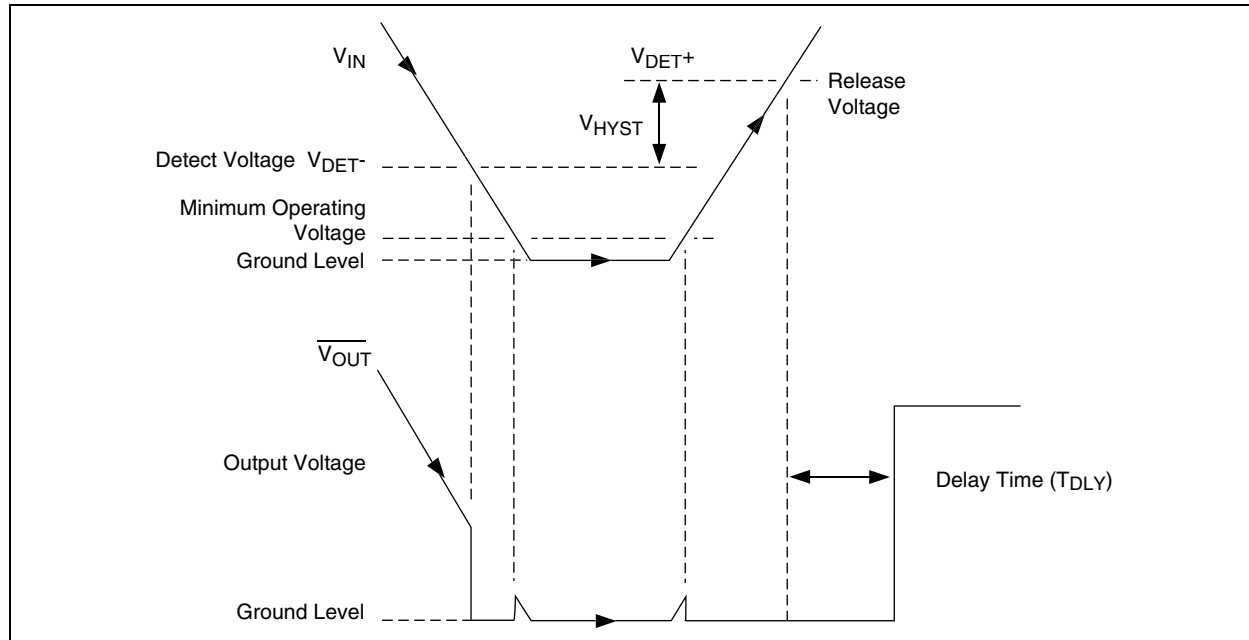

4.0 APPLICATIONS INFORMATION

4.1 Processor $\overline{\text{RESET}}$ Supervisor

Figure 4-1 shows the TC51 used as a processor reset supervisor. Because the TC51 is available in threshold settings of 1.6V to 6.0V, the user can choose the reset single threshold setting best suited to the system power supply voltage at hand. Also, the 1 μ A supply current is significantly lower than its nearest competitor.

As shown in the timing diagram (Figure 3-1), $\overline{\text{V}}_{\text{OUT}}$ is low for voltages between 0.7V and $V_{\text{DET+}}$. The TC51 activates its on-board delay timer once the power supply voltage is within tolerance (i.e., greater than $V_{\text{DET+}}$). $\overline{\text{V}}_{\text{OUT}}$ is released after delay time (T_{DLY}).

Should the power supply voltage momentarily dip (“brown-out” condition), the TC51 immediately drives and holds the processor $\overline{\text{RESET}}$ input low. $\overline{\text{RESET}}$ is released after the power supply voltage is again within tolerance, and after the delay timer expires. $\overline{\text{RESET}}$ is driven and held low when power fails (power-off or “blackout”), and is maintained down low to a supply voltage of 0.7V.

FIGURE 4-1: PROCESSOR $\overline{\text{RESET}}$ SUPERVISOR

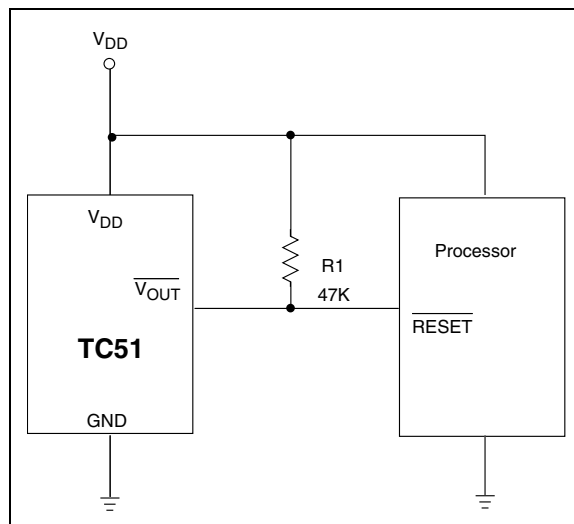
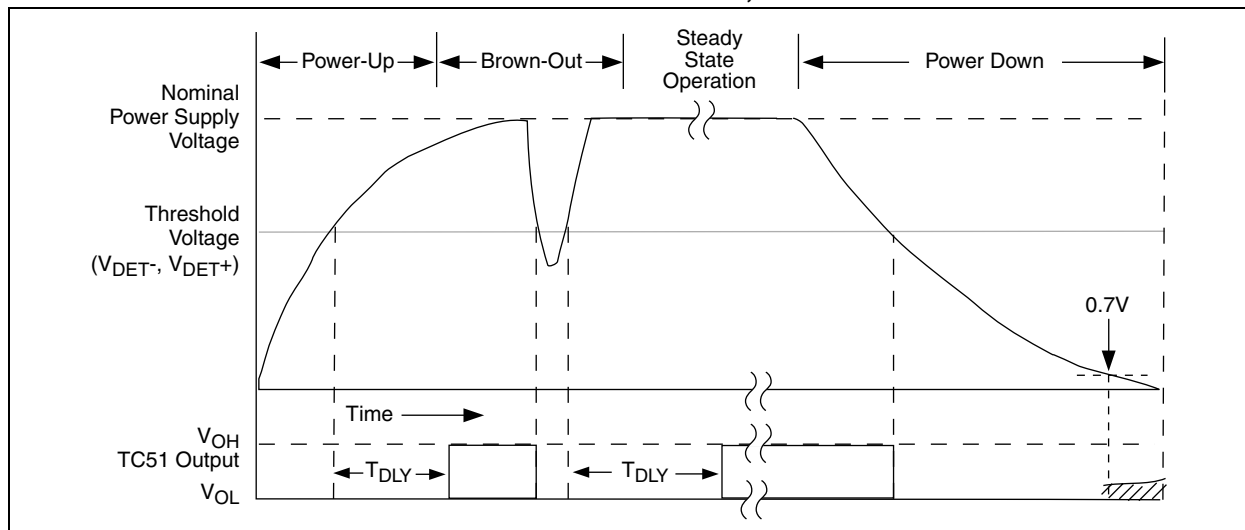

FIGURE 4-2: TC51 OPERATION DURING POWER-UP, BROWN-OUT AND POWER DOWN



5.0 TYPICAL CHARACTERISTICS

Note: The graphs and tables provided following this note are a statistical summary based on a limited number of samples and are provided for informational purposes only. The performance characteristics listed herein are not tested or guaranteed. In some graphs or tables, the data presented may be outside the specified operating range (e.g., outside specified power supply range) and therefore outside the warranted range.

1. SUPPLY CURRENT VS. INPUT VOLTAGE

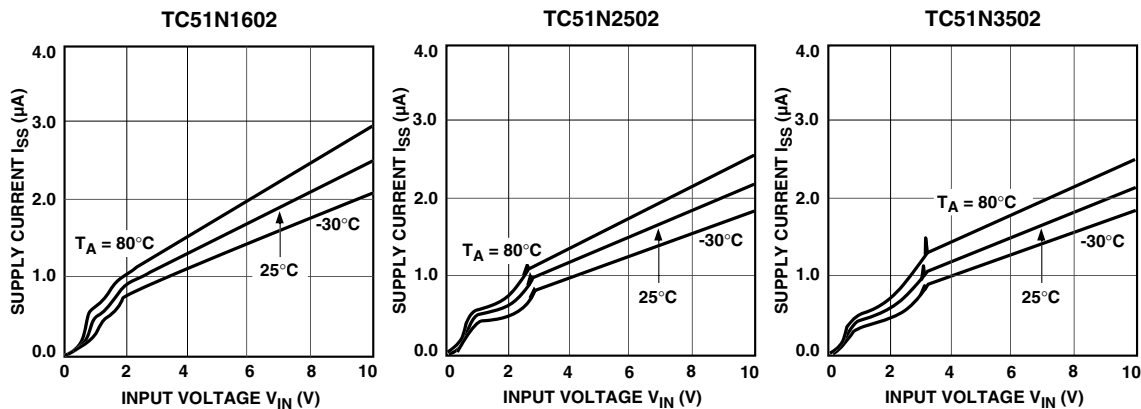

2. THRESHOLD VOLTAGE, HYSTERESIS VOLTAGE VS. AMBIENT TEMPERATURE

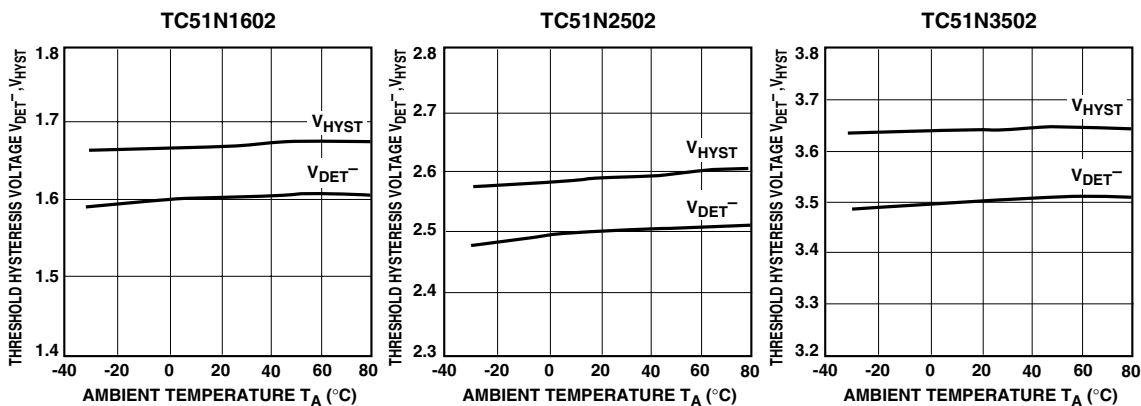

3. OUTPUT VOLTAGE VS. INPUT VOLTAGE

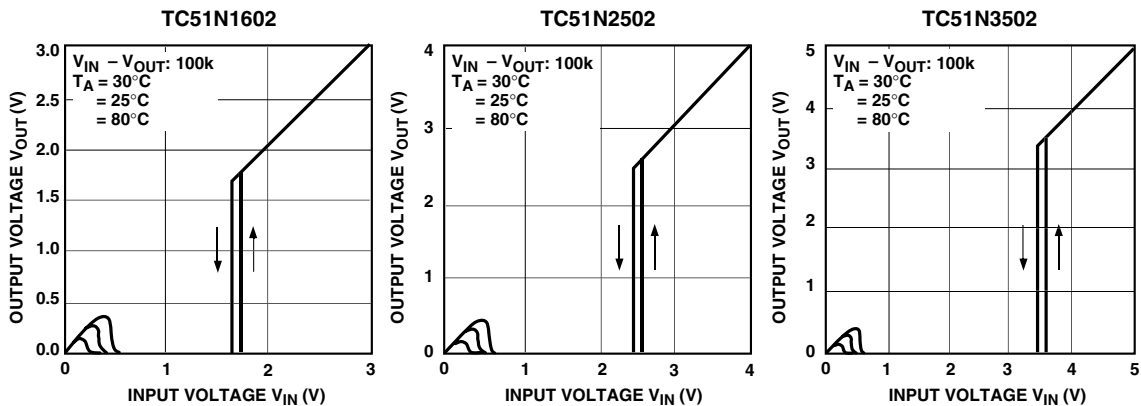

5.0 TYPICAL CHARACTERISTICS (CONTINUED)

4. OUTPUT CURRENT VS. V_{DS}

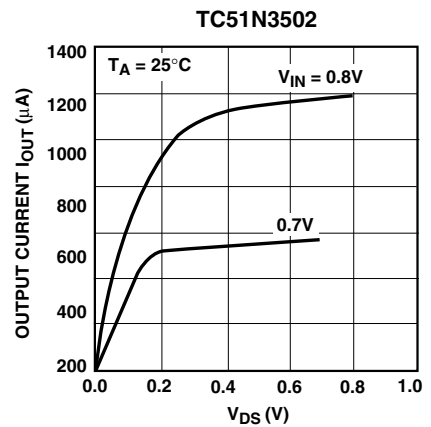
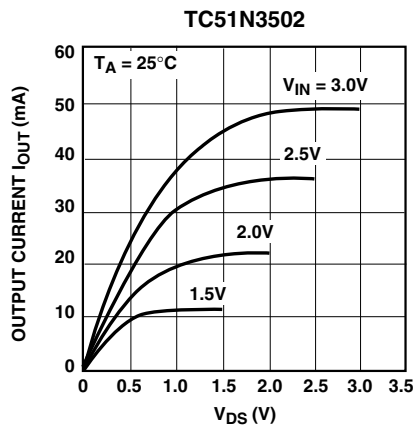
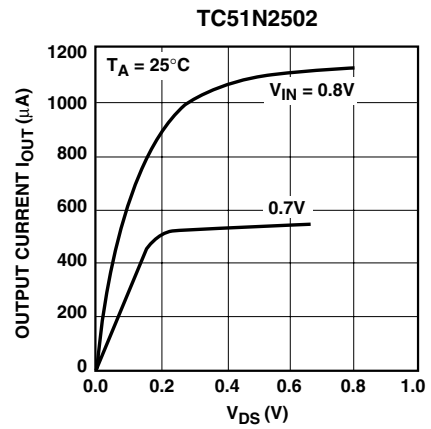
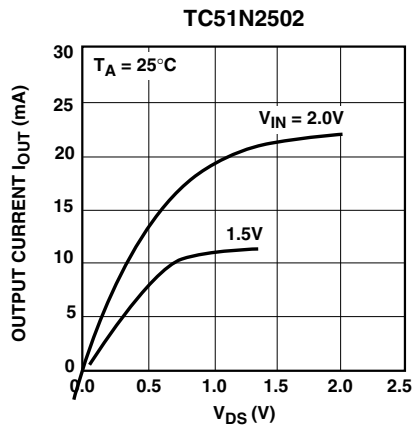
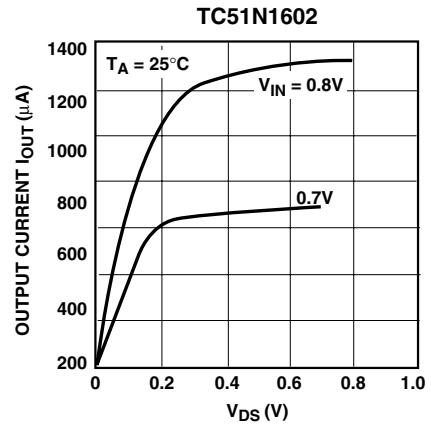
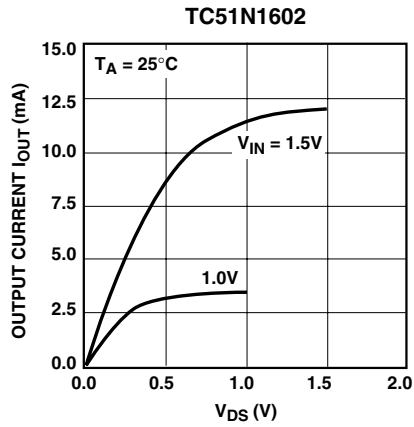

5.0 TYPICAL CHARACTERISTICS (CONTINUED)

5. OUTPUT CURRENT VS. INPUT VOLTAGE

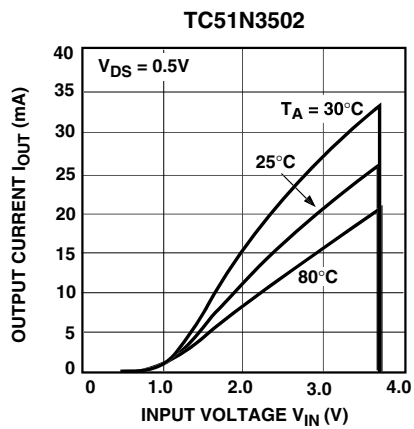
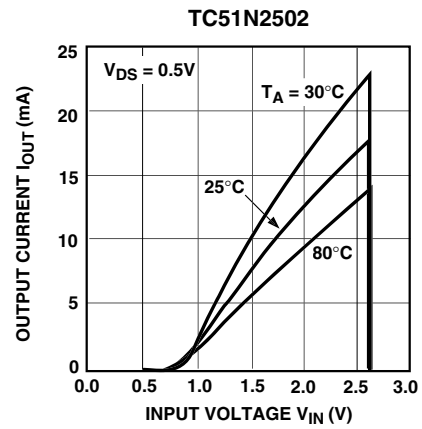
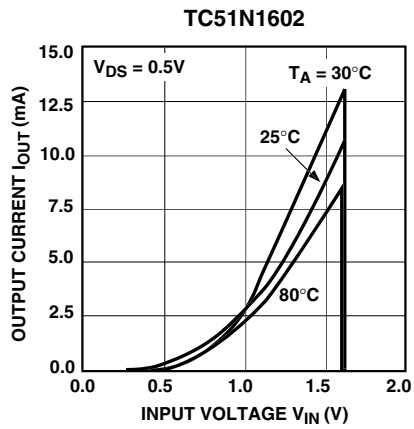

6.0 PACKAGING INFORMATION

6.1 Package Marking Information

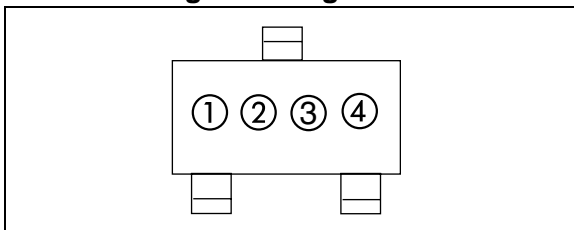

① represents N-channel indication and integer part of output voltage

Symbol	Output	Voltage
K	Nch	0.
L	Nch	1.
M	Nch	2.
N	Nch	3.
P	Nch	4.
R	Nch	5.
S	Nch	6.

② represents first decimal of output voltage

Symbol	Voltage
0	.0
1	.1
2	.2
3	.3
4	.4
5	.5
6	.6
7	.7
8	.8
9	.9

③ represents delay time

Symbol	Delay Time
5	50ms-200ms

④ represents assembly lot code

6.2 Taping Form

Component Taping Orientation for 3-Pin SOT-23A (EIAJ SC-59) Devices

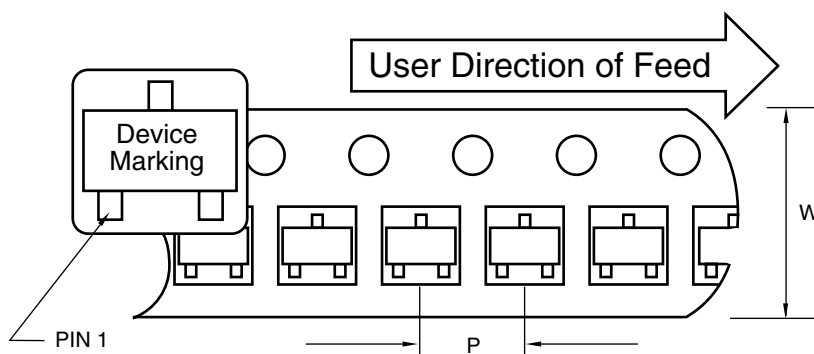

Standard Reel Component Orientation
for TR Suffix Device
(Mark Right Side Up)

Carrier Tape, Number of Components Per Reel and Reel Size

Package	Carrier Width (W)	Pitch (P)	Part Per Full Reel	Reel Size
3-Pin SOT-23A	8 mm	4 mm	3000	7 in

6.3 Package Dimensions

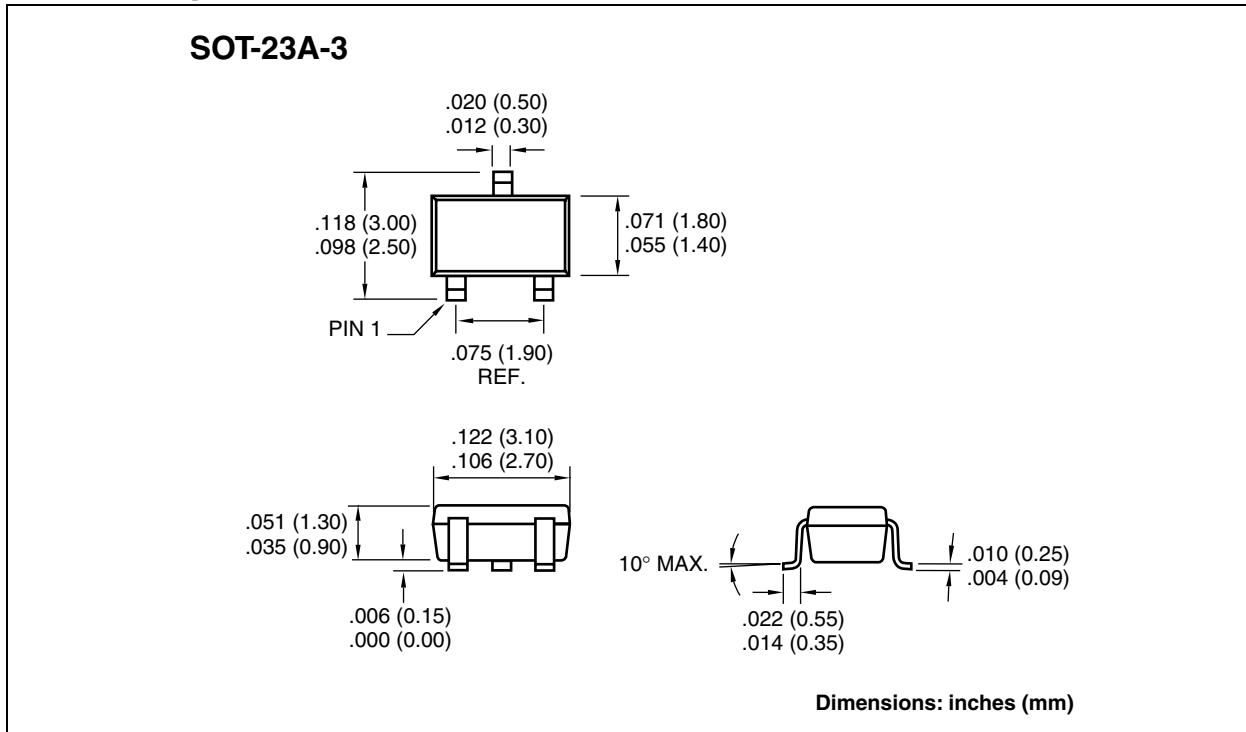

PRODUCT IDENTIFICATION SYSTEM

To order or obtain information, e.g., on pricing or delivery, refer to the factory or the listed sales office.

PART CODE	TC51	N	18	0	2	E	CB	XX
Output Configuration: N = Open Drain		_____						
Detected Voltage: Ex: 18 = 1.8V			_____					
Output Delay: 0 = 50msec-200msec (standard)				_____				
Tolerance: 2 = ±2%					_____			
Temperature: E: -40°C to +85°C						_____		
Package Type and Pin Count: CB: 3-Pin SOT-23A (equivalent to EIAJ SC-59)							_____	
Taping Direction: TR: Standard Taping								_____

Sales and Support

Data Sheets

Products supported by a preliminary Data Sheet may have an errata sheet describing minor operational differences and recommended workarounds. To determine if an errata sheet exists for a particular device, please contact one of the following:

1. Your local Microchip sales office
2. The Microchip Corporate Literature Center U.S. FAX: (480) 792-7277
3. The Microchip Worldwide Site (www.microchip.com)

Please specify which device, revision of silicon and Data Sheet (include Literature #) you are using.

New Customer Notification System

Register on our web site (www.microchip.com/cn) to receive the most current information on our products.

TC51

NOTES:

Information contained in this publication regarding device applications and the like is intended through suggestion only and may be superseded by updates. It is your responsibility to ensure that your application meets with your specifications. No representation or warranty is given and no liability is assumed by Microchip Technology Incorporated with respect to the accuracy or use of such information, or infringement of patents or other intellectual property rights arising from such use or otherwise. Use of Microchip's products as critical components in life support systems is not authorized except with express written approval by Microchip. No licenses are conveyed, implicitly or otherwise, under any intellectual property rights.

Trademarks

The Microchip name and logo, the Microchip logo, FilterLab, KEELOQ, microID, MPLAB, PIC, PICmicro, PICMASTER, PICSTART, PRO MATE, SEEVAL and The Embedded Control Solutions Company are registered trademarks of Microchip Technology Incorporated in the U.S.A. and other countries.

dsPIC, ECONOMONITOR, FanSense, FlexROM, fuzzyLAB, In-Circuit Serial Programming, ICSP, ICEPIC, microPort, Migratable Memory, MPASM, MPLIB, MPLINK, MPSIM, MXDEV, MXLAB, PICC, PICDEM, PICDEM.net, rPIC, Select Mode and Total Endurance are trademarks of Microchip Technology Incorporated in the U.S.A.

Serialized Quick Turn Programming (SQTP) is a service mark of Microchip Technology Incorporated in the U.S.A.

All other trademarks mentioned herein are property of their respective companies.

© 2002, Microchip Technology Incorporated, Printed in the U.S.A., All Rights Reserved.

 Printed on recycled paper.

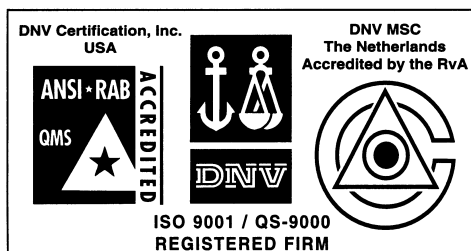

Microchip received QS-9000 quality system certification for its worldwide headquarters, design and wafer fabrication facilities in Chandler and Tempe, Arizona in July 1999 and Mountain View, California in March 2002. The Company's quality system processes and procedures are QS-9000 compliant for its PICmicro® 8-bit MCUs, KEELOQ® code hopping devices, Serial EEPROMs, microperipherals, non-volatile memory and analog products. In addition, Microchip's quality system for the design and manufacture of development systems is ISO 9001 certified.



WORLDWIDE SALES AND SERVICE

AMERICAS

Corporate Office

2355 West Chandler Blvd.
Chandler, AZ 85224-6199
Tel: 480-792-7200 Fax: 480-792-7277
Technical Support: 480-792-7627
Web Address: <http://www.microchip.com>

Rocky Mountain

2355 West Chandler Blvd.
Chandler, AZ 85224-6199
Tel: 480-692-7966 Fax: 480-792-7456

Atlanta

500 Sugar Mill Road, Suite 200B
Atlanta, GA 30350
Tel: 770-640-0034 Fax: 770-640-0307

Boston

2 Lan Drive, Suite 120
Westford, MA 01886
Tel: 978-692-3848 Fax: 978-692-3821

Chicago

333 Pierce Road, Suite 180
Itasca, IL 60143
Tel: 630-285-0071 Fax: 630-285-0075

Dallas

4570 Westgrove Drive, Suite 160
Addison, TX 75001
Tel: 972-818-7423 Fax: 972-818-2924

Detroit

Tri-Atria Office Building
32255 Northwestern Highway, Suite 190
Farmington Hills, MI 48334
Tel: 248-538-2250 Fax: 248-538-2260

Kokomo

2767 S. Albright Road
Kokomo, Indiana 46902
Tel: 765-864-8360 Fax: 765-864-8387

Los Angeles

18201 Von Karman, Suite 1090
Irvine, CA 92612
Tel: 949-263-1888 Fax: 949-263-1338

New York

150 Motor Parkway, Suite 202
Hauppauge, NY 11788
Tel: 631-273-5305 Fax: 631-273-5335

San Jose

Microchip Technology Inc.
2107 North First Street, Suite 590
San Jose, CA 95131
Tel: 408-436-7950 Fax: 408-436-7955

Toronto

6285 Northam Drive, Suite 108
Mississauga, Ontario L4V 1X5, Canada
Tel: 905-673-0699 Fax: 905-673-6509

ASIA/PACIFIC

Australia

Microchip Technology Australia Pty Ltd
Suite 22, 41 Rawson Street
Epping 2121, NSW
Australia
Tel: 61-2-9868-6733 Fax: 61-2-9868-6755

China - Beijing

Microchip Technology Consulting (Shanghai)
Co., Ltd., Beijing Liaison Office
Unit 915
Bei Hai Wan Tai Bldg.
No. 6 Chaoyangmen Beidajie
Beijing, 100027, No. China
Tel: 86-10-85282100 Fax: 86-10-85282104

China - Chengdu

Microchip Technology Consulting (Shanghai)
Co., Ltd., Chengdu Liaison Office
Rm. 2401, 24th Floor,
Ming Xing Financial Tower
No. 88 TIDU Street
Chengdu 610016, China
Tel: 86-28-86766200 Fax: 86-28-86766599

China - Fuzhou

Microchip Technology Consulting (Shanghai)
Co., Ltd., Fuzhou Liaison Office
Unit 28F, World Trade Plaza
No. 71 Wusi Road
Fuzhou 350001, China
Tel: 86-591-7503506 Fax: 86-591-7503521

China - Shanghai

Microchip Technology Consulting (Shanghai)
Co., Ltd.
Room 701, Bldg. B
Far East International Plaza
No. 317 Xian Xia Road
Shanghai, 200051
Tel: 86-21-6275-5700 Fax: 86-21-6275-5060

China - Shenzhen

Microchip Technology Consulting (Shanghai)
Co., Ltd., Shenzhen Liaison Office
Rm. 1315, 13/F, Shenzhen Kerry Centre,
Renminnan Lu
Shenzhen 518001, China
Tel: 86-755-2350361 Fax: 86-755-2366086

China - Hong Kong SAR

Microchip Technology Hongkong Ltd.
Unit 901-6, Tower 2, Metroplaza
223 Hing Fong Road
Kwai Fong, N.T., Hong Kong
Tel: 852-2401-1200 Fax: 852-2401-3431

India

Microchip Technology Inc.
India Liaison Office
Divyasree Chambers
1 Floor, Wing A (A3/A4)
No. 11, O'Shaugnessey Road
Bangalore, 560 025, India
Tel: 91-80-2290061 Fax: 91-80-2290062

Japan

Microchip Technology Japan K.K.
Benex S-1 6F
3-18-20, Shinyokohama
Kohoku-Ku, Yokohama-shi
Kanagawa, 222-0033, Japan
Tel: 81-45-471- 6166 Fax: 81-45-471-6122

Korea

Microchip Technology Korea
168-1, Youngbo Bldg. 3 Floor
Samsung-Dong, Kangnam-Ku
Seoul, Korea 135-882
Tel: 82-2-554-7200 Fax: 82-2-558-5934

Singapore

Microchip Technology Singapore Pte Ltd.
200 Middle Road
#07-02 Prime Centre
Singapore, 188980
Tel: 65-6334-8870 Fax: 65-6334-8850

Taiwan

Microchip Technology Taiwan
11F-3, No. 207
Tung Hua North Road
Taipei, 105, Taiwan
Tel: 886-2-2717-7175 Fax: 886-2-2545-0139

EUROPE

Denmark

Microchip Technology Nordic ApS
Regus Business Centre
Lautrup hoj 1-3
Ballerup DK-2750 Denmark
Tel: 45 4420 9895 Fax: 45 4420 9910

France

Microchip Technology SARL
Parc d'Activite du Moulin de Massy
43 Rue du Saule Trapu
Batiment A - 1er Etage
91300 Massy, France
Tel: 33-1-69-53-63-20 Fax: 33-1-69-30-90-79

Germany

Microchip Technology GmbH
Gustav-Heinemann Ring 125
D-81739 Munich, Germany
Tel: 49-89-627-144 0 Fax: 49-89-627-144-44

Italy

Microchip Technology SRL
Centro Direzionale Colleoni
Palazzo Taurus 1 V. Le Colleoni 1
20041 Agrate Brianza
Milan, Italy
Tel: 39-039-65791-1 Fax: 39-039-6899883

United Kingdom

Microchip Ltd.
505 Eskdale Road
Winnersh Triangle
Wokingham
Berkshire, England RG41 5TU
Tel: 44 118 921 5869 Fax: 44-118 921-5820

05/01/02

